

Data Sheet



Article number: 432000340

Description: Rota-fix shaft-hub connection A 340x425
Steel

Note: Not self centering. Medium-high torques.

Measures

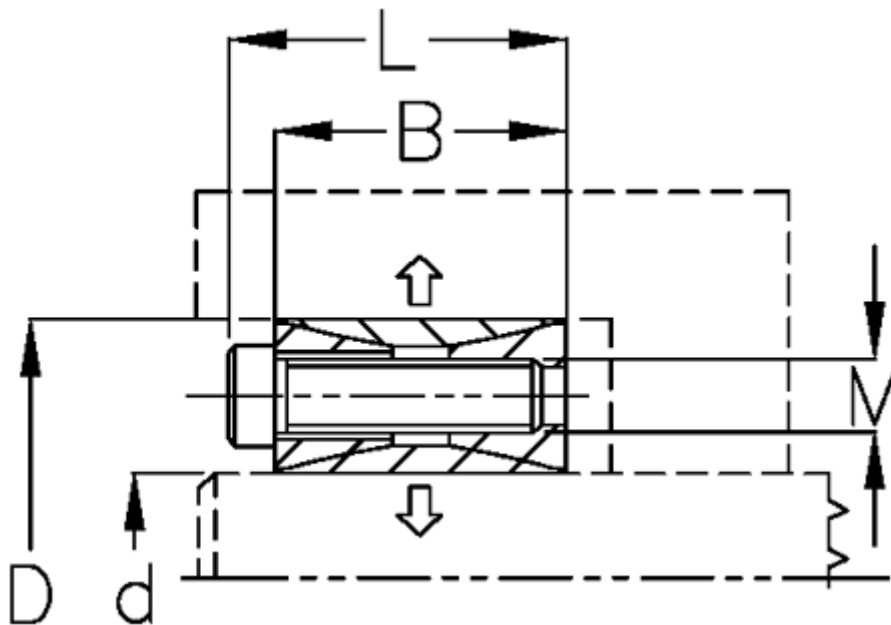

B mm	= 78
d H8 mm	= 340425
D mm	= 425
Fit tolerance	= Aksel k11-h11, Nav N11-H11
F kN torque	= 1482.0
L mm	= 98
M mm	= M20
P N/mm ² surface pressure on shaft/hub	= 129

Surface roughness	=
T N m torque	=
Ts N m bolt tightening torque	=